

# Ministar 429



ASSA ABLOY

ASSA ABLOY, the global leader  
in door opening solutions



# Ministar 429

**Maniglione antipanico da applicare con dimensioni ridotte idoneo anche per profili metallici e porte con fascia.**

**Caratteristiche:**

- Reversibile
- Modulare (per 1, 2 o 3 punti di chiusura)
- Adatto per porte ad anta singola o doppia
- Idoneo per porte tagliafuoco/antifumo
- Installabile anche su porte con profili metallici e porte con fascia
- Disponibile in diverse finiture e colori
- Larghezza gruppo meccanismo inferiore a 35 mm e altezza 103 mm
- Sporgenza dalla porta inferiore a 100 mm (categoria 2)
- Meccanismi in acciaio
- Braccini in zama
- Cover in acciaio
- Barre ovali disponibili in vari materiali, finiture e colori
- Abbinabile al Kit Maniglia Jolly 04480 oppure a solo cilindro esterno
- Certificato CE (EN1125) per porte montate su cerniere o perni, con massa oltre 200 kg, altezza non superiore a 2520 mm e larghezza non maggiore di 1320 mm

**Versioni disponibili:**

- Standard: reversibile
- Con micro-switch: sx o sx

**Da ordinare a parte:**

- Barra ovale
- Kit Scrocchi Alto/Basso
- Kit Aste Verticali
- Kit Maniglia Esterna (Maniglia "Jolly" 04480) oppure solo cilindro

**Testo per capitolati:**

Maniglione antipanico da applicare, tipo A, certificato per installazione su porte tagliafuoco/antifumo, con coperture di altezza 103 mm e larghezza inferiore a 35 mm, idoneo per porte ad anta singola o doppia, anche con profilo metallico o fascia.

**Rim panic exit device with small size, suitable also for metal profiles and doors with mid-rail.**

**Features:**

- Reversible
- Modular (for 1, 2 or 3 locking points)
- Suitable for single or double leaf doors
- Certified for fire rated doors
- Can be installed also on doors with metal profiles and doors with mid-rail
- Available in different finishes and colours
- Mechanism width lower than 35 mm and height of 103 mm
- Projection from the door surface lower than 100 mm (category 2)
- Steel mechanisms
- Zamak levers
- Steel covers
- Oval bars available in different materials, finishes and colours
- Can be combined with external "Jolly" handle kit 04480 or with only external cylinder
- CE certified (EN1125) for doors on hinges or pivots with weight over 200kg, height not higher than 2520 mm and width non greater than 1320 mm

**Versions available:**

- Standard: reversible
- With micro-switch: right or left

**To be ordered separately:**

- Oval bar
- Upper/Lower Latches Kit
- Vertical Rods Kit
- External Handle Kit ("Jolly" Handle 04480) or only cylinder

**Versions available:**

Rim panic exit device, type A, certified for fire rated doors, with covers height of 103mm and width lower than 35mm, suitable for single or double leaf doors also with metal profiles or mid-rail.



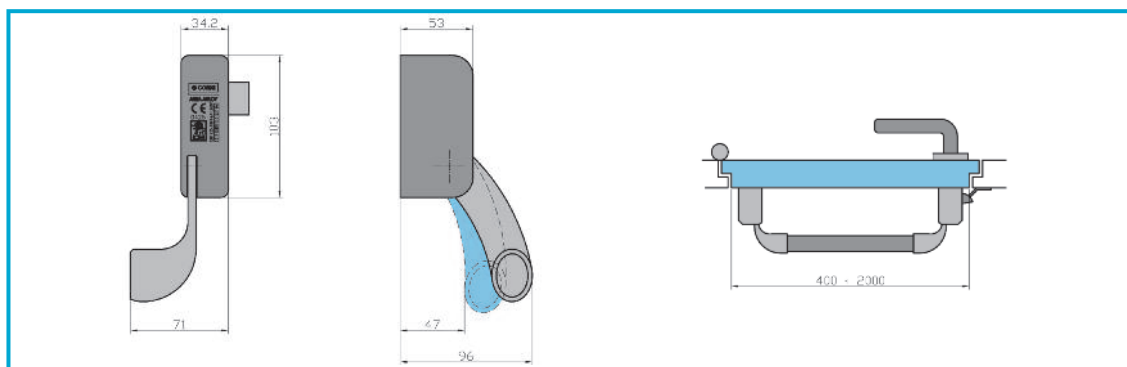

	Codice / Code	Finitura / Finish	gr.	
Reversibile Reversible	42906 00 000	Nero / Black	2.600	1
	42906 00 000GR	Grigio / Grey	2.600	1
	42906 00 000IN	Simil Inox / SS	2.600	1
	42906 00 000WH*	Bianco / White	2.600	1
	42906 00 000CR*	Cromo / Chrome	2.600	1
	42906 00 000AU*	Oro / Gold	2.600	1
Con micro-switch With micro-switch				
Destro / Right	42906 00 100MIC	Nero / Black	2.600	1
Sinistro / Left	42906 00 200MIC	Nero / Black	2.600	1

\* Finiture su richiesta  
\* Finishes upon request

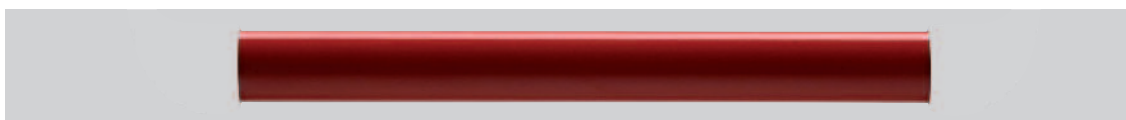

Codice / Code	Finitura / Finish	mm	gr.	
PAM26 00 01 00	All. anodizzato / anodized	900	470	1
PAM26 00 02 00	All. anodizzato / anodized	1200	824	1
PAM26 00 01 01	Inox satinato / satin	900	470	1
PAM26 00 02 01	Inox satinato / satin	1200	824	1
PAM26 00 03 01	Inox satinato / satin	1500	1180	1
PAM26 00 01 03	All. Simil inox	900	470	1
PAM26 00 02 03	All. Simil inox	1200	824	1
PAM26 00 03 03	All. Simil inox	1500	1180	1
PAM26 00 01 04*	All. Rosso / Red	900	470	1
PAM26 00 02 04*	All. Rosso / Red	1200	824	1
PAM26 00 03 04*	All. Rosso / Red	1500	1180	1
PAM26 00 01 07*	All. Grigio / Grey	900	470	1
PAM26 00 02 07*	All. Grigio / Grey	1200	824	1
PAM26 00 03 07*	All. Grigio / Grey	1500	1180	1
PAM26 00 02 10*	Inox lucido / polished	1200	824	1

\* Finiture su richiesta (sostituire le ultime due cifre del codice con le seguenti in base alla finitura scelta):

\*02 = Nero (extra 6 €) \*05 = Verde (extra 6 €) \*06 = Bianco (extra 6 €) \*08 = Oro (extra 25 €)

\* Finishes upon request (replace the last two digits of the code with the following ones according to the selected finish):

\*02 = Black (extra 6 €) \*05 = Green (extra 6 €) \*06 = White (extra 6 €) \*08 = Gold (extra 25 €)

#### Chiusura laterale

Lateral Locking

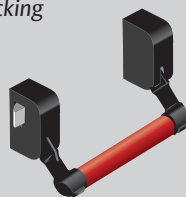

Per la reversibilità e per ottenere soluzioni a due punti di chiusura è necessario disabilitare uno o entrambi gli scrocci centrali non utilizzati per mezzo dei tappi copriforo in nylon inclusi nella confezione del maniglione.  
Per le combinazioni possibili, fare riferimento alla parte "Configurazioni" alla fine del documento.

#### Chiusura duplice

Double locking

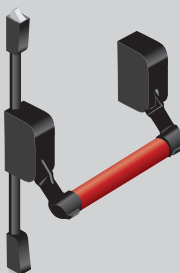

For the reversibility and for having two locking points solutions, it's necessary to disable one or both the central latches not needed using the nylon caps included in the box.  
For the combinations possible, see the relevant part "Compositions" at the end of the document.

#### Chiusura tripla

Three locking points

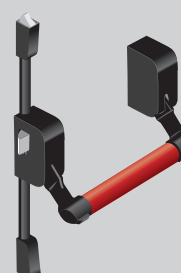

# Accessori per Ministar

## Accessories for Ministar

### Kit Scrocchi Alto/Basso Verticali

#### Upper/Lower Vertical Latches Kits



Codice / Code	Finitura / Finish		
03429 00 000	Nero / Black	1.000	1
03429 00 000GR	Grigio / Grey	1.000	1
03429 00 000IN	Simil Inox / SS	1.000	1
03429 00 000WH*	Bianco / White	1.000	1
03429 00 000CR*	Cromo / Chrome	1.000	1
03429 00 000AU*	Oro / Gold	1.000	1

\* Finiture su richiesta / Finishes upon request

### Kit Scrocchi Alto/Basso Laterali

#### Upper/Lower Lateral Latches Kits



Codice / Code	Finitura / Finish		
03429 00 050	Nero / Black	1.000	1
03429 00 050GR	Grigio / Grey	1.000	1
03429 00 050IN	Simil Inox / SS	1.000	1
03429 00 050WH*	Bianco / White	1.000	1
03429 00 050CR*	Cromo / Chrome	1.000	1
03429 00 050AU*	Oro / Gold	1.000	1

### Kit Scrocchi Alto Verticale/Basso Laterale

#### Upper Vertical/Lower Lateral Latches Kit



Dx	03429 00 100	Nero / Black	1.000	1
Dx	03429 00 100GR	Grigio / Grey	1.000	1
Dx	03429 00 100IN	Simil Inox / SS	1.000	1
Dx	03429 00 100WH*	Bianco / White	1.000	1
Dx	03429 00 100CR*	Cromo / Chrome	1.000	1
Dx	03429 00 100AU*	Oro / Gold	1.000	1
Sx	03429 00 200	Nero / Black	1.000	1
Sx	03429 00 210GR	Grigio / Grey	1.000	1
Sx	03429 00 200IN	Simil Inox / SS	1.000	1
Sx	03429 00 200WH*	Bianco / White	1.000	1
Sx	03429 00 200CR*	Cromo / Chrome	1.000	1
Sx	03429 00 200AU*	Oro / Gold	1.000	1

\* Finiture su richiesta / Finishes upon request



Codice / Code	H. (mm) porte/doors	L. (mm) aste superiori / upper rods		
---------------	------------------------	--	---	---

### Kit aste verticali con copriaste



#### Vertical rods Kit with covers

Nero / Black	04444 00 000	da 2200	1162	1.150	1
Grigio / Grey	04444 00 000GR	da 2200	1162	1.150	1
Simil Inox / SS	04444 00 000IN	da 2200	1162	1.150	1
Bianco / White	04444 00 000WH*	da 2200	1162	1.150	1
Cromo / Chrome	04444 00 000CR*	da 2200	1162	1.150	1
Oro / Gold	04444 00 000AU*	da 2200	1162	1.150	1
Nero / Black	04444 01 000	da 2400	1362	1.310	1
Grigio / Grey	04444 01 000GR	da 2400	1362	1.310	1
Simil Inox / SS	04444 01 000IN	da 2400	1362	1.310	1
Bianco / White	04444 01 000WH*	da 2400	1362	1.310	1
Cromo / Chrome	04444 01 000CR*	da 2400	1362	1.310	1
Oro / Gold	04444 01 000AU*	da 2400	1362	1.310	1

\* Finiture su richiesta / Finishes upon request

# Accessori per Ministar



## Accessories for Ministar

Codice / Code	H. (mm) porte/doors	L. (mm) aste superiori / upper rods			
Kit aste verticali con copriaste Vertical rods Kit with covers					
Nero / Black	04444 02 000	da 2600	1562	1.400	1
Grigio / Grey	04444 02 000GR	da 2600	1562	1.400	1
Simil Inox / SS	04444 02 000IN	da 2600	1562	1.400	1
Bianco / White	04444 02 000WH*	da 2600	1562	1.400	1
Cromo / Chrome	04444 02 000CR*	da 2600	1562	1.400	1
Oro / Gold	04444 02 000AU*	da 2600	1562	1.400	1
Nero / Black	04444 03 000	da 2800	1762	1.490	1
Grigio / Grey	04444 03 000GR	da 2800	1762	1.490	1
Simil Inox / SS	04444 03 000IN	da 2800	1762	1.490	1
Bianco / White	04444 03 000WH*	da 2800	1762	1.490	1
Cromo / Chrome	04444 03 000CR*	da 2800	1762	1.490	1
Oro / Gold	04444 03 000AU*	da 2800	1762	1.490	1
Nero / Black	04444 04 000	da 3000	1962	1.690	1
Grigio / Grey	04444 04 000GR	da 3000	1962	1.690	1
Simil Inox / SS	04444 04 000IN	da 3000	1962	1.690	1
Bianco / White	04444 04 000WH*	da 3000	1962	1.690	1
Cromo / Chrome	04444 04 000CR*	da 3000	1962	1.690	1
Oro / Gold	04444 04 000AU*	da 3000	1962	1.690	1



\* Finiture su richiesta / Finishes upon request



Kit rosetta e mezzo cilindro  
Single cylinder with escutcheon kit

Codice / Code	Finitura Finish	Spess. porte Door thickness		
Cod. CC505001810162B = 88 (78-10) mm				
04440 05 000	Nichelato / Nickel plated	max 50 mm	190	1
Cod. CC505002010162B = 91 (81-10) mm				
04440 06 000	Nichelato / Nickel plated	max 60 mm	195	1



Codice / Code	Finitura / Finish		
Maniglia universale "Jolly" con cilindro profilato intercambiabile con altri cilindri di sicurezza Universal handle Kit "Jolly" with profile cylinder interchangeable with other security cylinders			
04480 08 000	Nero / Black	500	1
04480 08 000GR	Grigio / Grey	500	1
04480 08 000IN	Simil Inox / SS	500	1
04480 08 000WH*	Bianco / White	500	1
04480 08 000CR*	Cromo / Chrome	500	1
04480 08 000AU*	Oro / Gold	500	1
04480 08 000MIC	Nero / Black	500	1

\* Finiture su richiesta / Finishes upon request

# Accessori per Ministar

## Accessories for Ministar

Codice / Code	Finitura / Finish		
---------------	-------------------	---	---

Adattatore per maniglione per abbinamento al Kit Maniglia "Jolly" 04480 08  
*Adapter for panic exit device for combination with "Jolly" handle Kit 04480 08*

04419 06 000	-	50	1
--------------	---	----	---



Codice / Code		
---------------	---	---

Contropiastra a pavimento (Ricambio) / *Floor strike plate (Spare Part)*

02400 02 000	70	10
--------------	----	----



Codice / Code		
---------------	---	---

Contropiastra laterale e superiore completa di 4 spessori (Ricambio)  
*Lateral and upper strike plate including 4 ticknesses (Spare Part)*

02400 03 000	40	10
--------------	----	----

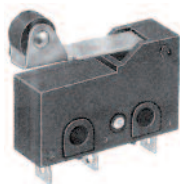

Codice / Code		
---------------	---	---

Coppia micro-switch  
*Pair of micro-switches*

04400 00 000	20	1
--------------	----	---

# Schemi di applicazione

## *Applications patterns*

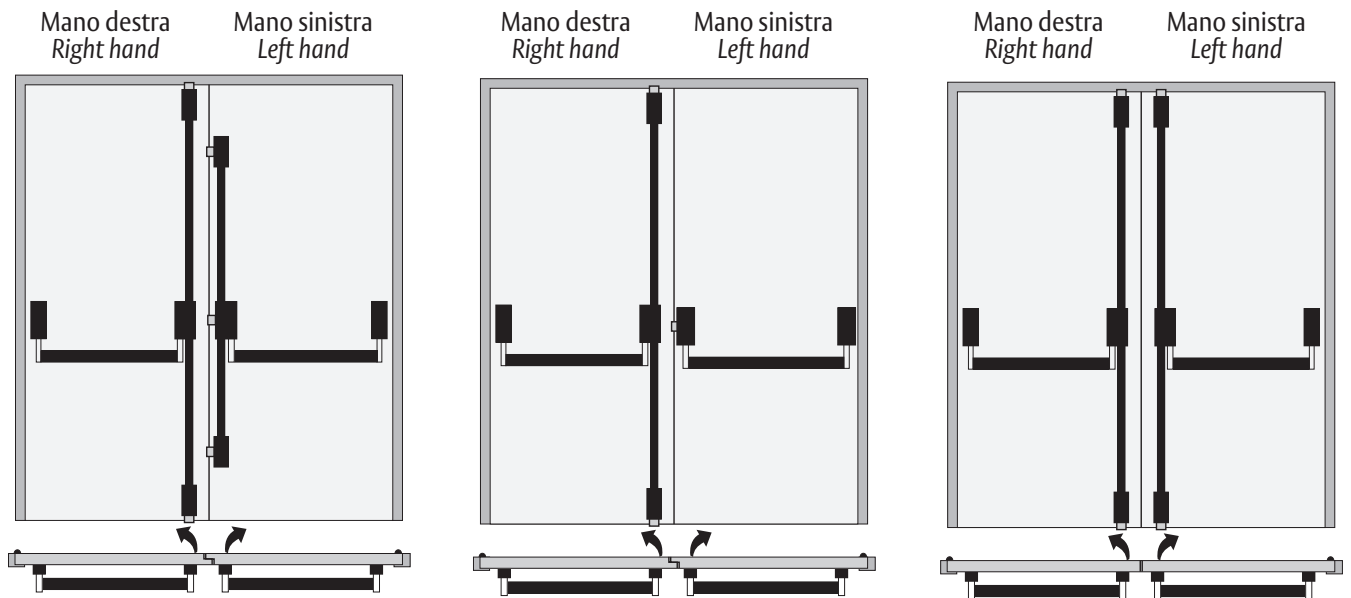
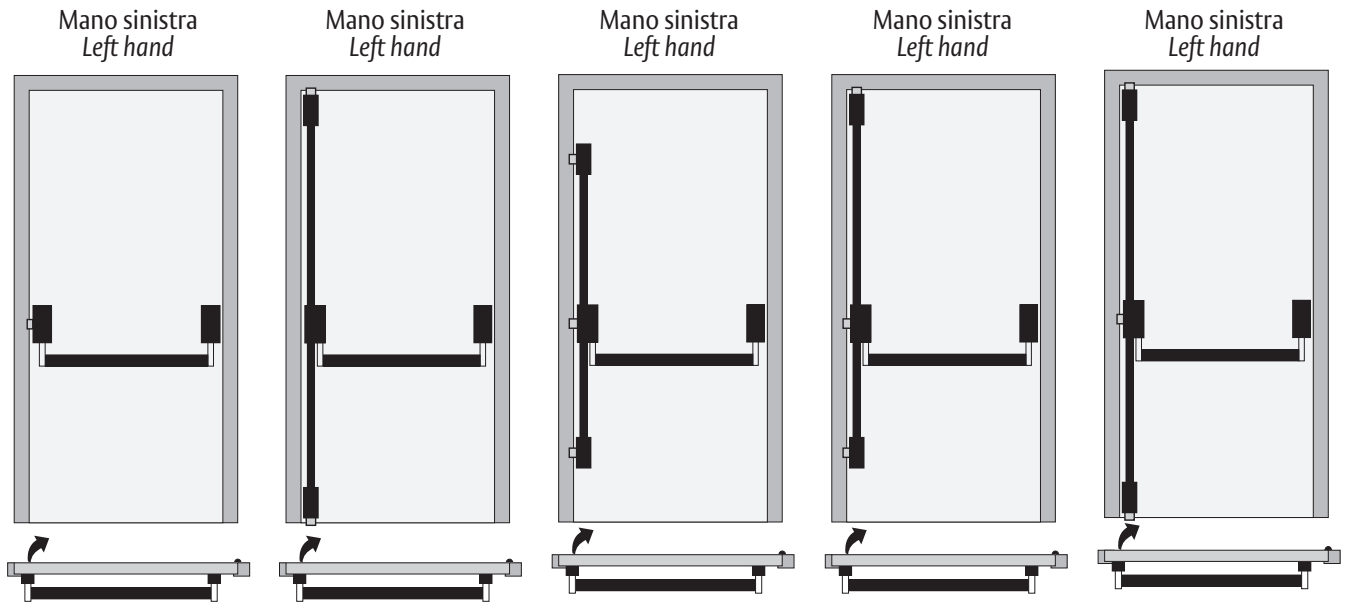

# Configurazioni per Porte ad Anta Singola

## Compositions for Single Leaf Doors

X = Necessari / Necessary  
 □ = Facoltativi / Optional  
 ● = Alternativi / Alternative

xxx = Finiture e/o varianti (vedere listino)  
 Finishes and/or variants (see price list)

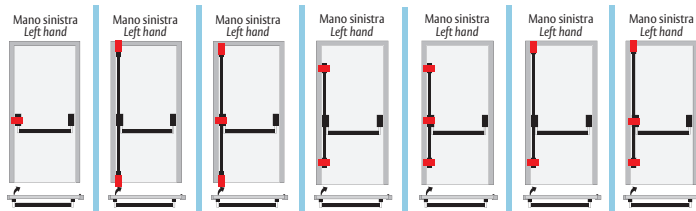

	Centrale Central	42906xxx	X	X	X	X	X	X	X	Anta Primaria / Primary Leaf
	A/B Verticali Upper/Lower Vertical	0342900000xxx	-	X	X	-	-	-	-	
	A/B Lateral Upper/Lower Lateral	0342900050xxx	-	-	-	X	X	-	-	
	Alto Verticale Basso Laterale Upper Vertical Lower Lateral	0342900100/200xxx	-	-	-	-	-	X	X	
	Kit Aste Verticali con Copriaste/Vertical Rods Kit with Covers	04444xxx	-	X	X	X	X	X	X	
	Barra Bar	PAM260001xxx (900 mm)	● X	● X	● X	● X	● X	● X	● X	
		PAM260002xxx (1200 mm)	● X	● X	● X	● X	● X	● X	● X	
		PAM260003xxx (1500 mm)	● X	● X	● X	● X	● X	● X	● X	
	Kit Maniglia Esterna External Handle Kit	0448008xxx	□ ●	□ ●	□ ●	□ ●	□ ●	□ ●	□ ●	
	Cilindro singolo Single Cylinder	04440xxx	□ ●	□ ●	□ ●	□ ●	□ ●	□ ●	□ ●	
	Centrale Central	42906xxx	-	-	-	-	-	-	-	Anta Secondaria/Secondary Leaf
	A/B Verticali Upper/Lower Vertical	0342900000xxx	-	-	-	-	-	-	-	
	Kit Aste Verticali con Copriaste/Vertical Rods Kit with Covers	04444xxx	-	-	-	-	-	-	-	
	Barra Bar	PAM260001xxx (900 mm)	-	-	-	-	-	-	-	
		PAM260002xxx (1200 mm)	-	-	-	-	-	-	-	
		PAM260003xxx (1500 mm)	-	-	-	-	-	-	-	



# Configurazioni per Porte ad Anta Doppia

## Compositions for Double Leaf Doors

- X = Necessari / Necessary
- = Facoltativi / Optional
- = Alternativi / Alternative

xxx = Finiture e/o varianti (vedere listino)  
Finishes and/or variants (see price list)

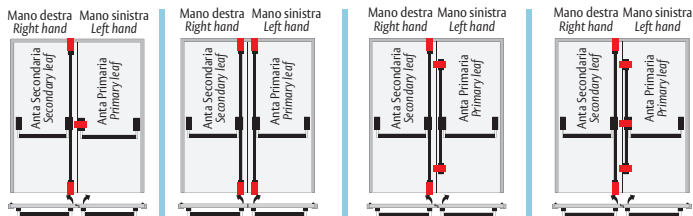

	Centrale Central	42906xxx	X	X	X	X	Anta Primaria / Primary Leaf	
		A/B Verticali Upper/Lower Vertical	034290000xxx	-	X	-		-
		A/B Lateral Upper/Lower Lateral	0342900050xxx	-	-	X		X
		Alto Verticale Basso Laterale Upper Vertical Lower Lateral	0342900100/200xxx	-	-	-		-
		Kit Aste Verticali con Copriaste/Vertical Rods Kit with Covers	04444xxx	-	X	X		X
		Barra Bar	PAM260001xxx (900 mm)	● X	● X	● X		● X
			PAM260002xxx (1200 mm)	● X	● X	● X		● X
			PAM260003xxx (1500 mm)	● X	● X	● X		● X
		Kit Maniglia Esterna External Handle Kit	0448008xxx	□ ●	□ ●	□ ●		□ ●
		Cilindro singolo Single Cylinder	04440xxx	□ ●	□ ●	□ ●		□ ●
	Centrale Central	42906xxx	X	X	X	X	Anta Secondaria/Secondary Leaf	
		A/B Verticali Upper/Lower Vertical	034290000xxx	X	X	X		X
			Kit Aste Verticali con Copriaste/Vertical Rods Kit with Covers	04444xxx	X	X		X
			Barra Bar	PAM260001xxx (900 mm)	● X	● X		● X
		PAM260002xxx (1200 mm)		● X	● X	● X		● X
		PAM260003xxx (1500 mm)		● X	● X	● X		● X







ASSA ABLOY Italia S.p.A.  
Via Bovaresa 13 - 40017 San Giovanni in Persiceto (BO) Italy  
Tel. +39 051 6812411 - Fax +39 051 827486  
info@assaabloy.it - www.assaabloy.it

ASSA ABLOY is the  
global leader in door  
opening solutions,  
dedicated to satisfying  
end-user needs for  
security, safety and  
convenience.

[www.assaabloy.com](http://www.assaabloy.com)



ASSA ABLOY Italia S.p.A. si riserva di apportare in qualunque momento e senza preavviso le modifiche necessarie per migliorare ed evolvere le caratteristiche dei propri prodotti. Fotografate, illustrazioni e descrizioni sono da ritenersi indicative.  
ASSA ABLOY Italia S.p.A. reserves the right at any time, and without notice, the necessary modifications in order to improve and evolve the characteristics of their products. Photographs, illustrations and descriptions ought to be considered as indicative.

H001D11 / 01-2013